











OTR TYRES

barkleytyres.com



BARKLEY

CONTENT

About Barkley	04
Summary of uses	05
Radial	06
 BLB01	07
 BLB05S	08
 BLM06S	09
 BLB02S	10
 BLB03S+	11
 BLB06S+	12
 BLB07S+	13
 BLM02	14
Diagonal	16
 BBE01	17
 BBE02	18
 BBE03	19
Barkley online	20
Technical data	21
Why you should choose Barkley	25

Easily and quickly find the tyre you are looking for?
Then check out our online possibilities
on page 20.

COMPLETE RANGE OF OTR TYRES

Do you want competitively priced tyres for a loader, grader, scraper, articulated or rigid dump truck, mobile crane or an underground machine? Then you've come to the right place! We are your specialist in OTR tyres, as well as agricultural and truck tyres. By bundling market knowledge, design and product development, we are able to supply the innovative range of tyres you are looking for. The tyres meet all preferences, requirements and regulations in all sectors within the European market. But we supply more than just tyres. We are also able to

assist you when it comes to specialised knowledge of tyres and their uses. Our large delivery network means fast delivery is part of the service. And our competitive prices are an extra bonus. **Barkley is able to excel thanks to its quality, price and service.** So look no further; Barkley is the brand you are looking for!

We offer a wide range of tyres for the OTR segment, in many sizes and varying patterns. Exactly what you need for your OTR machine!

	Construction	Mining
Grader	BLB01 07 BBE02 18 BBE03 19	
Loader	BLB01 07 BLB05S 08 BLB06S+ 12 BLB07S+ 13 BBE01 17 BBE03 19	BLB06S+ 12 BLB07S+ 13
Articulated Dumptruck	BLB01 07 BLB05S 08 BLM06S 09 BBE01 17	
Rigid Dumptruck	BLB02S 10 BLB03S+ 11	
Underground Machine		BLB06S+ 12 BLB07S+ 13
Mobile crane	BLM02 14	

RADIAL TYRES

RADIAL TYRES - BLB01



AVAILABLE SIZES

Size	Pattern	Star rating	L/S Index	TRA-code	TL/TT	Recommended wheel	Max. load	Inflated pressure (bar)	Width (mm)	Diameter (mm)	Tread depth (mm)	Load-bearing radius (mm)	Rolling circumference (mm)	Weight (kg)
17.5R25	BLB01	**	167B/182A2	E3/L3	TL	14.00/1.5	8500	5.75	440	1330	28	599	4057	176
20.5R25	BLB01	**	177B/193A2	E3/L3	TL	17.00/2.0	11500	5.75	510	1476	31	664	4502	259
23.5R25	BLB01	**	185B/201A2	E3/L3	TL	19.50 /2.5	14500	5.75	590	1600	34	720	4880	343
26.5R25	BLB01	**	193B/209A2	E3/L3	TL	22.00/3.0	18500	5.75	662	1730	37	779	5277	439
29.5R25	BLB01	**	200B/216A2	E3/L3	TL	25.00/3.5	22400	5.75	724	1873	40	843	5713	524

Flexible tyres, which are strong and capable of effectively dealing with shocks from the road surface. These are the properties offered by our wide range of radial OTR tyres.

Barkley's radial tyres ensure good quality, better road contact, improved driving comfort and lower fuel consumption.



- ▶ Suitable for loaders, graders and articulated dumptrucks
- ▶ Excellent traction
- ▶ Self-cleaning tread



BLB01

RADIAL TYRES - BLB05S

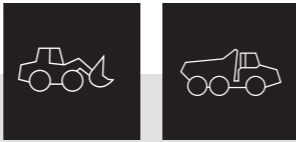

AVAILABLE SIZE

Size	Pattern	Star rating	L/S Index	TRA-code	TL/TT	Recommended wheel	Max. load	Inflated pressure (bar)	Width (mm)	Diameter (mm)	Tread depth (mm)	Load-bearing radius (mm)	Rolling circumference (mm)	Weight (kg)
750/65R25	BLB05S	**	190B/202A2	E3/L3	TL	24.00/3.0	15000	4.25	746	1600	46	720	4880	462

RADIAL TYRES - BLM06S



AVAILABLE SIZES

Size	Pattern	Star rating	L/S Index	TRA-code	TL/TT	Recommended wheel	Max. load	Inflated pressure (bar)	Width (mm)	Diameter (mm)	Tread depth (mm)	Load-bearing radius (mm)	Rolling circumference (mm)	Weight (kg)
26.5R25	BLM06S	**	193B/209A2	E4	TL	22.00/3.0	18500	5.75	673	1798	57	809	584	523
29.5R25	BLM06S	**	200B/216A2	E4	TL	25.00/3.5	22700	5.75	750	1921	62	864	5859	665



- ▶ Suitable for loaders and articulated dumptrucks
- ▶ Extra wide tread for excellent stability
- ▶ Excellent traction



BLB05S



- ▶ Suitable for articulated dumptrucks
- ▶ Excellent traction
- ▶ Robust rubber compound which is resistant against incisions

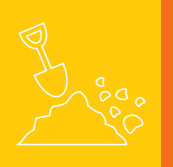

BLM06S

RADIAL TYRES - BLB02S



AVAILABLE SIZE

Size	Pattern	Star rating	L/S Index	TRA-code	TL/TT	Recommended wheel	Max. load	Inflated pressure (bar)	Width (mm)	Diameter (mm)	Tread depth (mm)	Load-bearing radius (mm)	Rolling circumference (mm)	Weight (kg)
18.00R33	BLB02S	**	191B/209A2	E4	TL	13.00/2.5	18500	8.0	478	1856	54	835	5661	455



- ▶ Suitable for rigid dumptrucks
- ▶ Excellent resistance against incisions
- ▶ Superb traction and high stability



BLB02S

RADIAL TYRES - BLB03S+



AVAILABLE SIZES

Size	Pattern	Star rating	L/S Index	TRA-code	TL/TT	Recommended wheel	Max. load	Inflated pressure (bar)	Width (mm)	Diameter (mm)	Tread depth (mm)	Load-bearing radius (mm)	Rolling circumference (mm)	Weight (kg)
16.00R25	BLB03S+	**	177B/195A2	E4	TL	11.25/2.0	12150	8.0	428	1525	43	686	4651	264
18.00R25	BLB03S+	**	185B/204A2	E4	TL	13.00/2.5	16000	8.0	493	1654	47	744	5045	350



- ▶ Suitable for rigid dumptrucks
- ▶ Long life-span and improved driving comfort
- ▶ Self-cleaning tread



BLB03S+

RADIAL TYRES - BLB06S+



AVAILABLE SIZES

Size	Pattern	Star rating	L/S Index	TRA-code	TL/TT	Recommended wheel	Max. load	Inflated pressure (bar)	Width (mm)	Diameter (mm)	Tread depth (mm)	Load-bearing radius (mm)	Rolling circumference (mm)	Weight (kg)
17.5R25	BLB06S+	**	182A2	L5	TL	14.00/1.5	8500	5.75	445	1399	65	630	4267	278
20.5R25	BLB06S+	**	193A2	L5	TL	17.00/2.0	11500	5.75	520	1548	72	697	4721	348
23.5R25	BLB06S+	**	201A2	L5	TL	19.50/2.5	14500	5.75	597	1673	78.5	753	5103	469
26.5R25	BLB06S+	**	209A2	L5	TL	22.00/3.5	18500	5.75	673	1798	87.5	809	5484	608
29.5R25	BLB06S+	**	216A2	L5	TL	25.00/3.5	22400	5.75	750	1921	95	864	5859	747

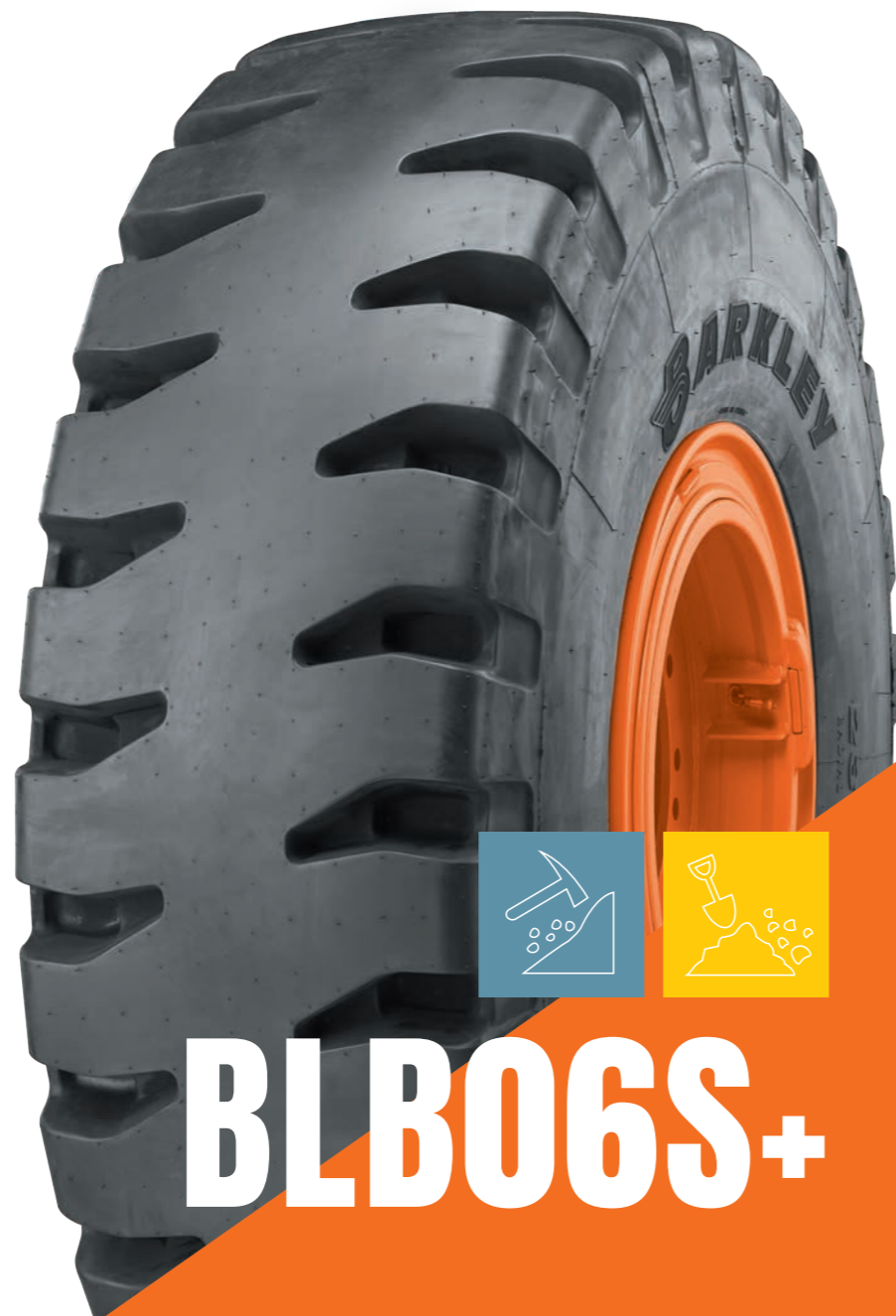

- ▶ Suitable for loaders and underground mining machines
- ▶ Extra deep grooves and robust rubber compound which is resistant against incisions
- ▶ High stability and well suited to very demanding circumstances

BLB06S+

RADIAL TYRES - BLB07S+

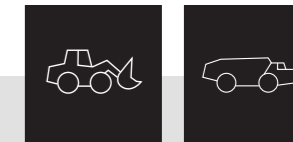

AVAILABLE SIZES

Size	Pattern	Star rating	L/S Index	TRA-code	TL/TT	Recommended wheel	Max. load	Inflated pressure (bar)	Width (mm)	Diameter (mm)	Tread depth (mm)	Load-bearing radius (mm)	Rolling circumference (mm)	Weight (kg)
20.5R25	BLB07S+	**	193A2	L5	TL	17.00/2.0	11500	5.75	520	1548	72	697	4721	348
23.5R25	BLB07S+	**	201A2	L5	TL	19.50/2.5	14500	5.75	597	1673	78.5	753	5103	469
26.5R25	BLB07S+	**	209A2	L5	TL	22.00/3.0	18500	5.75	673	1798	87.5	809	5484	582
29.5R25	BLB07S+	**	216A2	L5	TL	25.00/3.5	22400	5.75	750	1921	95	864	5859	747



- ▶ Suitable for loaders and underground mining machines
- ▶ Extra deep tread gives exceptional grip in rough and demanding circumstances
- ▶ Superb self-cleaning tread

BLB07S+

RADIAL TYRES - BLM02

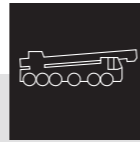

AVAILABLE SIZES

Size	Pattern	Star rating	L/S Index	TRA-code	TL/TT	Recommended wheel	Max. load	Inflated pressure (bar)	Width (mm)	Diameter (mm)	Tread depth (mm)	Load-bearing radius (mm)	Rolling circumference (mm)	Weight (kg)
385/95R25	BLM02	**	170E	E2	TL	10.00/1.5	6000	9.0	370	1360	22	612	4148	173
445/95R25	BLM02	**	177E	E2	TL	11.25/2.0	7300	9.0	430	1476	24	664	4502	215



- ▶ Suitable for mobile cranes
- ▶ Excellent stability
- ▶ Reduced rolling circumference



BLM02



WE ALSO SUPPLY TRUCK AND AGRICULTURAL TYRES

Contact us for personal advice:

✉ info@barkleytyres.com

☎ +31 (0)523 850 850



DIAGONAL TYRES

DIAGONAL TYRES - BBE01

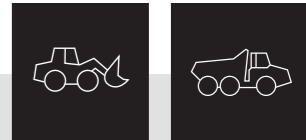

AVAILABLE SIZES

Size	Pattern	Star rating	L/S Index	TRA-code	TL/TT	Recommended wheel	Max. load	Inflated pressure (bar)	Width (mm)	Diameter (mm)	Tread depth (mm)	Load-bearing radius (mm)	Rolling circumference (mm)	Weight (kg)
20.5-25	BBE01	16PR	167B/181A2	E3/L3	TL	17.00/2.0	8250	3.5	520	1490	28.5	663	4545	151
23.5-25	BBE01	20PR	177B/191A2	E3/L3	TL	19.50/2.5	10900	3.75	595	1615	31.5	719	4926	223
26.5-25	BBE01	28PR	188B/203A2	E3/L3	TL	22.00/3.0	15500	4.75	675	1750	40	779	5338	294
29.5-25	BBE01	28PR	193B/207A2	E3/L3	TL	25.00/3.5	17500	4.25	750	1875	40	834	5719	380

We can to assist you when it comes to robust OTR tyres for industrial purposes!

Barkley's diagonal tyres ensure high vehicle stability and higher resistance against damage to the tyre's side walls.

- ▶ Suitable for loaders and articulated dumptrucks
- ▶ Reinforced casing protects against incisions
- ▶ Excellent traction



BBE01

DIAGONAL TYRES - BBE02



AVAILABLE SIZE

Size	Pattern	Star rating	L/S Index	TRA-code	TL/TT	Recommended wheel	Max. load	Inflated pressure (bar)	Width (mm)	Diameter (mm)	Tread depth (mm)	Load-bearing radius (mm)	Rolling circumference (mm)	Weight (kg)
14.00-24	BBE02	12PR	147A8/172A2	G2	TL	8.00TG	6300	4.25	360	1350	24	601	4118	77

DIAGONAL TYRES - BBE03



AVAILABLE SIZES

Size	Pattern	Star rating	L/S Index	TRA-code	TL/TT	Recommended wheel	Max. load	Inflated pressure (bar)	Width (mm)	Diameter (mm)	Tread depth (mm)	Load-bearing radius (mm)	Rolling circumference (mm)	Weight (kg)
15.5-25	BBE03	12PR	149B/168A2	E2/L2	TL	12.00/1.3	5600	4.0	395	1275	25	567	3889	87
17.5-25	BBE03	12PR	153B/171A2	E2/L2	TL	14.00/1.5	6150	3.5	445	1350	25.5	601	4118	100
20.5-25	BBE03	16PR	167B/181A2	E2/L2	TL	17.00/2.0	8250	3.5	520	1490	28.5	663	4545	160



- ▶ Suitable for graders
- ▶ Maximum traction
- ▶ Self-cleaning pattern



BBE02



- ▶ Suitable for graders and loaders
- ▶ Improved stability
- ▶ Exceptional traction in rough and demanding conditions



BBE03

BARKLEY IS ALSO YOUR PARTNER ONLINE

barkleytyres.com

Knowledge, speed and convenience. Visit barkleytyres.com to find information about the wide range of tyres we can offer you. You will also find more information about our brand, the sectors in which we operate and the technical background of our tyres.

Would you like to know if one of the tyres you saw online is actually compatible with your specific situation or purpose? Then please contact us for personal advice. We will always be able to assist you, be it online or in person.

**WE CAN ALWAYS HELP YOU,
BOTH ONLINE AND IN PERSON**

 barkleytyres.com

 +31 (0)523 850 850

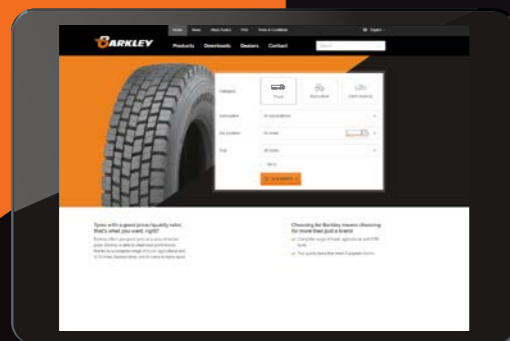
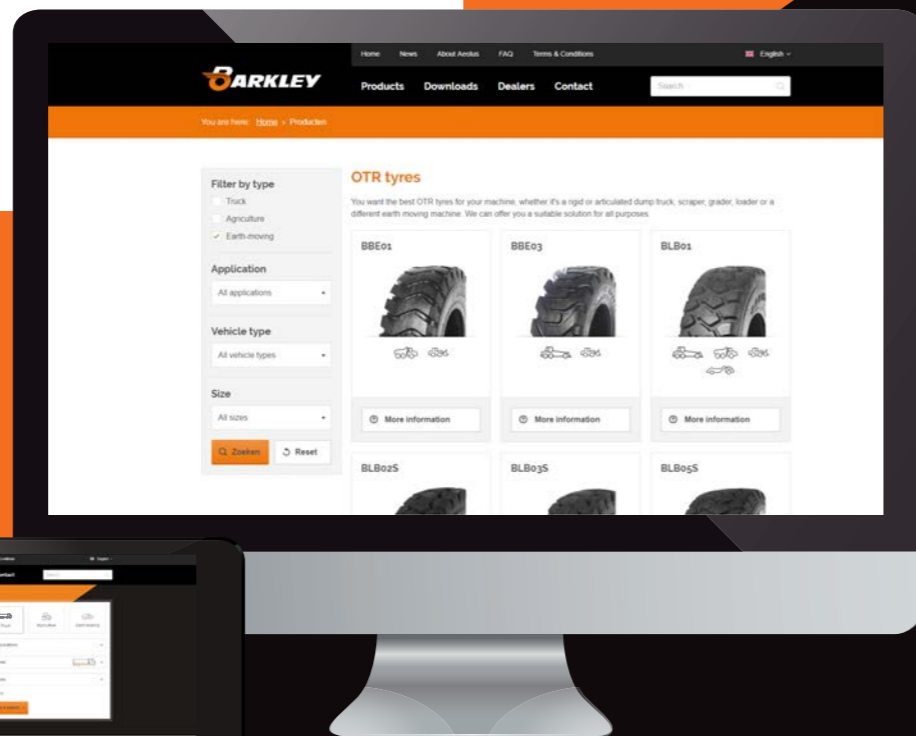

TECHNICAL DATA



RADIAL TYRES

Radial tyres were developed in 1946. There was a need for more flexible tyres, which were able to absorb shocks generated by road surfaces. These tyres are also stronger, which means machines can be operated at higher capacities.

In radial tyres, steel cord plies are placed in the heel of the tyre, and a belt is placed across the casing. Because cord plies are placed directly on top of each other, the side walls of radial tyres remain very flexible. The image clearly shows the various layers featured in a radial tyre. The bottom layer features steel cord plies and gives the tyre its most important properties.

DIAGONAL TYRES

Diagonal tyres have been used instead of full rubber tyres since 1898. They were a standard feature in the car industry before radial tyres were introduced.

Diagonal tyres consist of casing layers made from nylon cord. They are placed diagonally across each other in the tread and the side walls, at an angle of 55 degrees. Diagonal tyres are used, for example, to perform activities in ports (reach stacker). The image shows how the various layers are placed diagonally on top of each other.

Advantages

- ▷ Good steering and better road contact
- ▷ Improved driving comfort thanks to flexible side walls
- ▷ Little heat generated in tyre at high speeds
- ▷ Higher resistance against tread-related damage
- ▷ Lower fuel consumption

Disadvantages

- ▷ The soft side walls are vulnerable when, for example, vehicles collide with curbstones
- ▷ Minor bumps in roads are dealt with less effectively because radial tyres feature a steel belt

Advantages

- ▷ Improved vehicle stability
- ▷ Higher resistance against side wall damages

Disadvantages

- ▷ High rolling resistance, which causes tyres to quickly heat up
- ▷ Reduced comfort due to the tyre's rigidity
- ▷ Increased fuel consumption

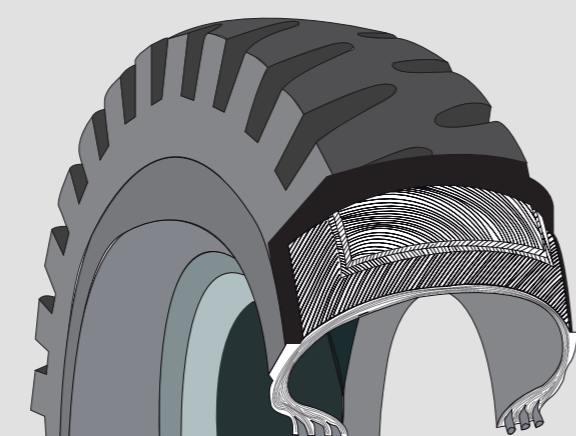
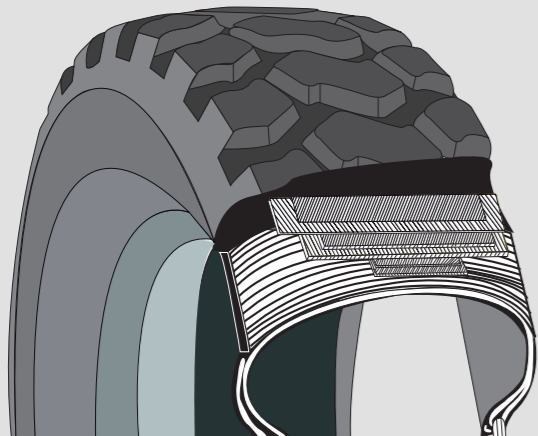

READING TYRES

The technical data provided on the following pages – in diagrams and tables – corresponds to the renowned international standards pursuant to ISO and ETRTO. Other tyre data such as the static loaded radius of the tyre is in accordance with DIN or WdK guidelines.

- A External diameter
- B Width
- H Loaded radius
- F Rim diameter
- Q Cross section
- Z Minimum distance, twin tyres

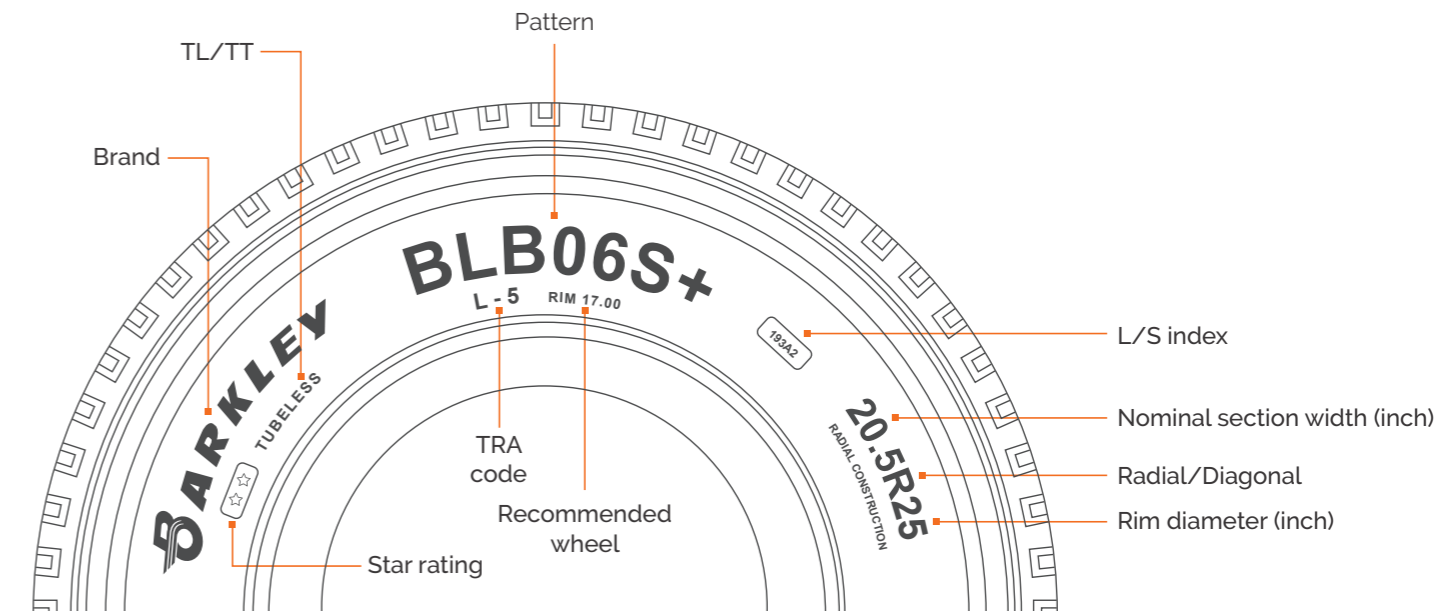
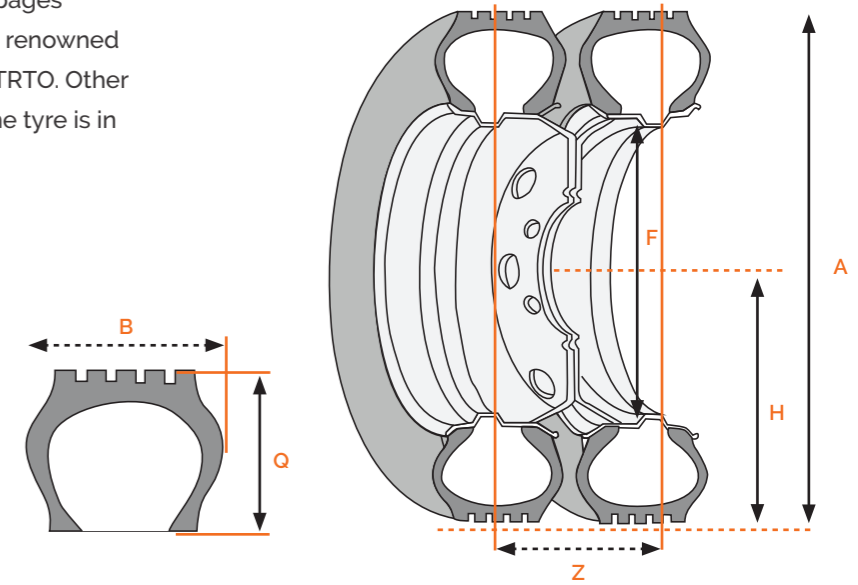

TREAD DEPTH (TRA CLASSIFICATION)

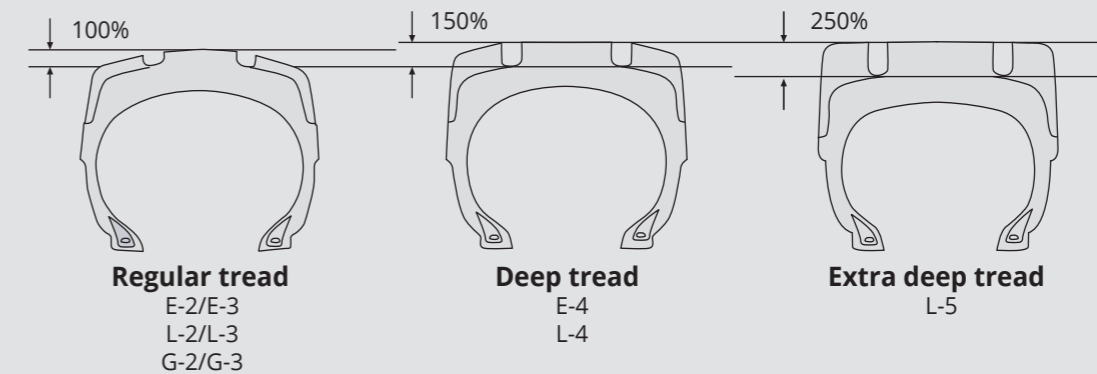

LOAD INDEX

Load index	Weight in kg
100	800
101	825
102	850
103	875
104	900
105	925
106	950
107	975
108	1.000
109	1.030
110	1.060
111	1.090
112	1.120
113	1.150
114	1.180
115	1.215
116	1.250
117	1.285
118	1.320
119	1.360
120	1.400
121	1.450
122	1.500
123	1.550
124	1.600
125	1.650
126	1.700
127	1.750
128	1.800
129	1.850
130	1.900
131	1.950
132	2.000
133	2.060
134	2.120
135	2.180
136	2.240
137	2.300
138	2.360
139	2.430
140	2.500
141	2.575
142	2.650
143	2.725
144	2.800
145	2.900
146	3.000
147	3.075
148	3.150
149	3.250
150	3.350
151	3.450

Load index	Weight in kg
152	3.550
153	3.650
154	3.750
155	3.875
156	4.000
157	4.125
158	4.250
159	4.375
160	4.500
161	4.625
162	4.750
163	4.875
164	5.000
165	5.150
166	5.300
167	5.450
168	5.600
169	5.800
170	6.000
171	6.150
172	6.300
173	6.500
174	6.700
175	6.900
176	7.100
177	7.300
178	7.500
179	7.750
180	8.000
181	8.250
182	8.500
183	8.750
184	9.000
185	9.250
186	9.500
187	9.750
188	10.000
189	10.300
190	10.600
191	10.900
192	11.200
193	11.500
194	11.800
195	12.150
196	12.500
197	12.850
198	13.200
199	13.600
200	14.000
201	14.500
202	15.000
203	15.500

Load index	Weight in kg
204	16.000
205	16.500
206	17.000
207	17.500
208	18.000
209	18.500
210	19.000
211	19.500
212	20.000
213	20.600
214	21.200
215	21.800
216	22.400
217	23.000
218	23.600

SPEED INDEX

Speed symbol	Speed in km
A1	5
A2	10
A3	15
A4	20
A5	25
A6	30
A7	35
A8	40
B	50
D	65
E	70
F	80
G	90
J	100
K	110
L	120
M	130
N	140
Q	160
R	170
S	180
T	190
U	200
H	210
V	240
W	270
Y	300

CHOOSING FOR BARKLEY MEANS CHOOSING MORE THAN JUST A TYRE



Complete range of truck, agricultural and OTR tyres



Great quality tyres that meet European norms



Affordable: excellent price per operating hour



Quickly available from stock



Specialised knowledge about tyres and uses





Zwedenweg 17
7772 TC Hardenberg
The Netherlands

T +31 (0)523 850 850
F +31 (0)523 850 855

barkleytyres.com